

LIYAN PROGRAMMABLE LOGIC CONTROLLER

***LYPLC***

***Ex1n8AD***

***Ex1n8TC***

USER'S MANUAL

## Foreword

- ◆ This manual contains text, diagrams and explanations which will guide the reader in the correct installation and operation of the Ex1n8AD Analog input block, It should be read and understood before attempting to install or use the unit. If in doubt about the operation or use of Ex1n8AD Analog input block please consult Liyan Electric.

## Introduction

The Ex1n8AD analog input block (hereafter referred to as “Ex1n8AD”) converts 8 points of analog input values (voltage input, current input, temperature input) into digital values, and transfers them to the PLC main unit.

The Ex1n8AD can be connected to Ex1n, Ex2n Series PLC.

- 1) Analog inputs can be selected from the voltage input, the current input and the thermocouple input (temperature input) by the input mode setting by the TO instruction given by the PLC main unit and the connection method.
- 2) The voltage input can be selected within the range from  $-10$  to  $+10$  V. The current input can be selected within the range from  $+4$  to  $+20$  mA.  
The thermocouple input can be selected among the K type, and J type. (The input characteristics cannot be adjusted when the thermocouple input is used.)
- 3) The resolution is  $5\text{mV}$  ( $20\text{ V} \times 1/4,000$ ) when the voltage input is used,  $10.00\ \mu\text{A}$  ( $40\text{ mA} \times 1/8,000$ ) when the current input is used, and  $0.1\ ^\circ\text{C}$  when the thermocouple input is used.

## External Dimensions

Dimension: mm

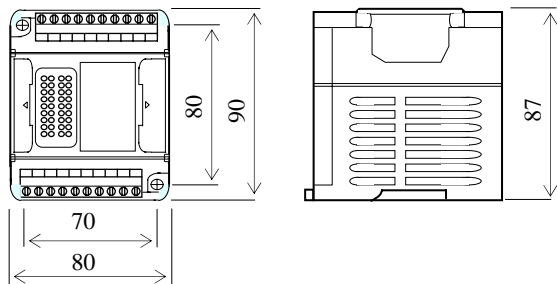

**Terminal Signal:** This module don't occupy any I/O points and never perform wiring to  terminals.

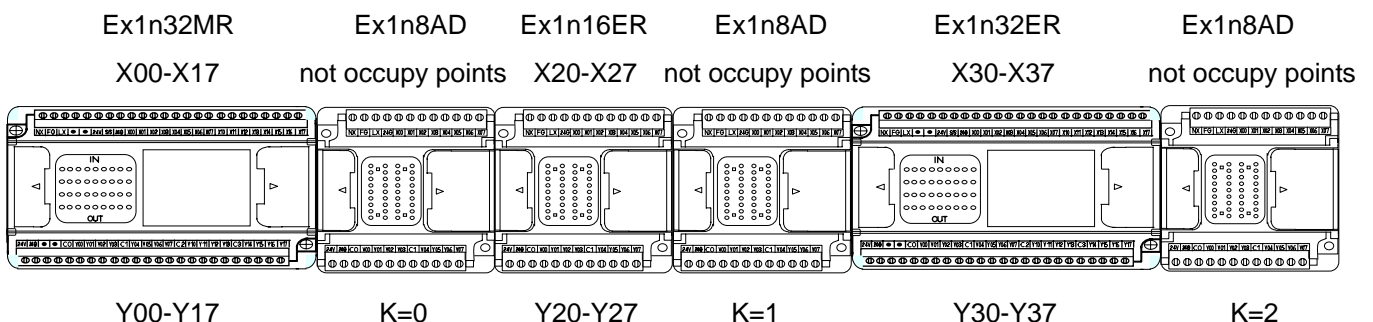

## Status indicator LED

Indication	Description
PRG	Lit while PLC main unit 8AD module is communicating.
RUN	Lit while power is normally supplied to “24V” and “24G” terminals of Ex1n8AD.

## Ex1n8AD Wiring

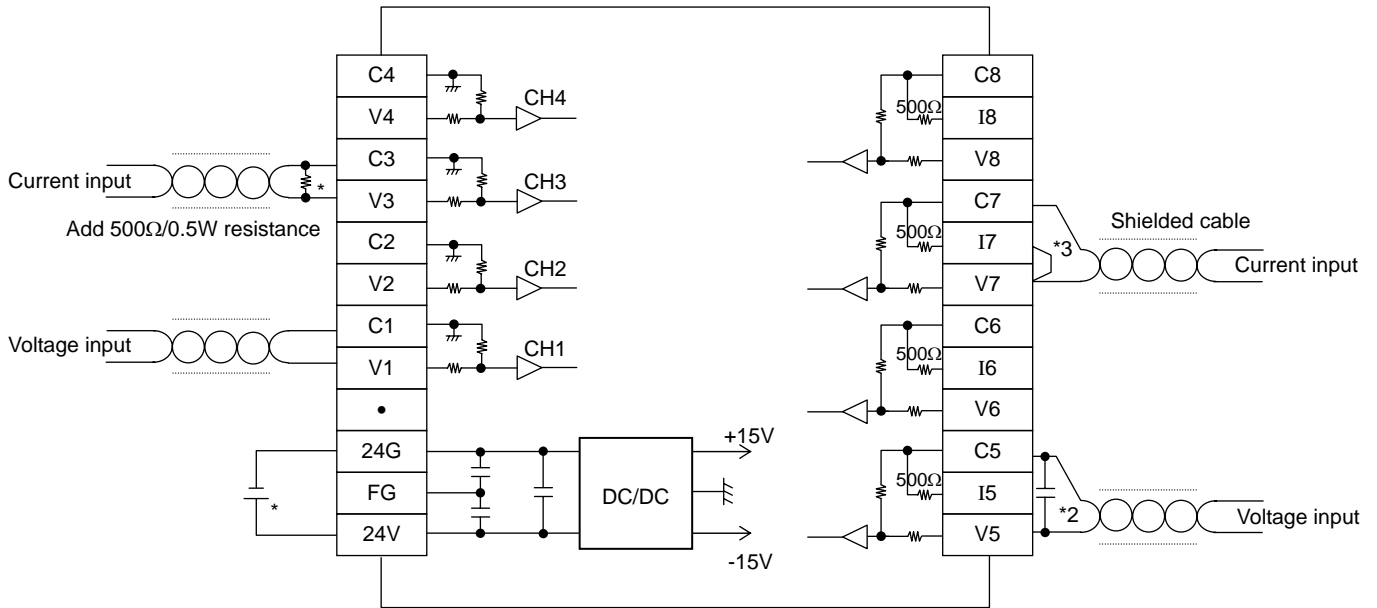

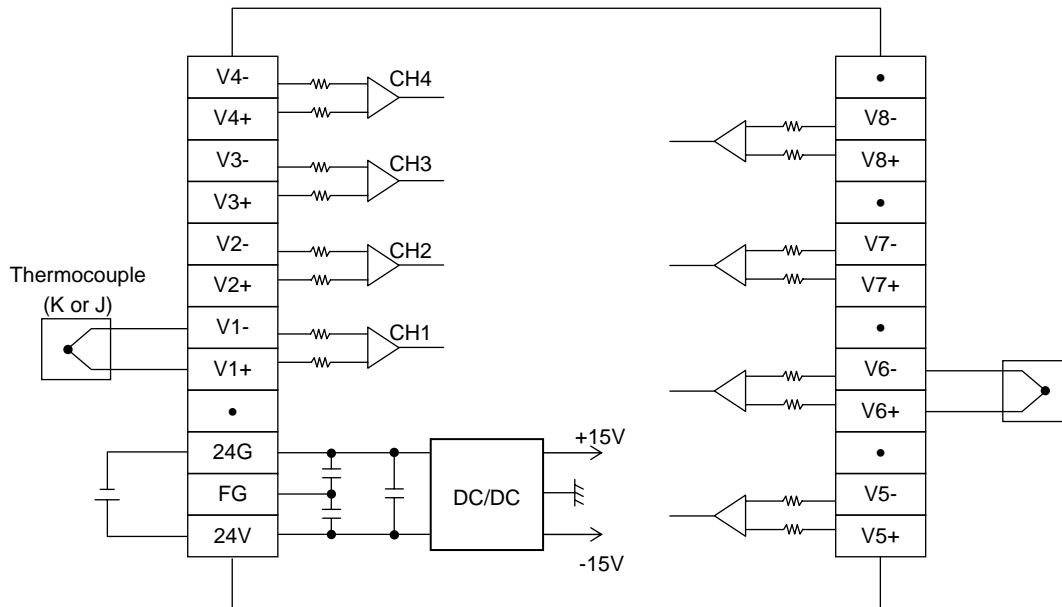

## Ex1n8TC Wiring



### Note:

- 1) To avoid effects of noise to make result is not accurate, please use cable with isolation and should be far away high-voltage power supply.
- 2) To avoid electric shock or damage of product, turn off all power supply when performing wiring work.

### Remark:

- \*1 Use a two-core, twisted, shielded cable for the analog input line, and separate it from other power lines or a lines easily induced.
- \*2 If there is voltage ripple in the input or there is noise in the external wiring, connect a capacitor of approximately 0.1 to 0.47  $\mu\text{F}$ , 25 V.
- \*3 For the current input, make sure to short-circuit the "VN+" terminal and the "IN+" terminal (N: input channel No.).
- \*4 Make sure to connect the  terminal to the  terminal of the PLC main unit to which Class D grounding (100  $\Omega$  or less) is performed.

## Specifications

### General specifications

Item	Specifications
Ambient temperature range	0 to +55 °C during operation, storage temperature: -20~70°C
Ambient humidity	35 to 85 % RH during operation (Dew condensation shall not be allowed.)
Noise resistance	Noise voltage 1,000 Vp-p, noise width 1 μs.
Withstand voltage	500 V AC for 1 min (between analog input terminal and each terminal of PLC main unit)
Insulation resistance	DC500V / 5 MΩ
Operating atmosphere	Corrosive gas and many dusts shall not be detected.

### Power supply specifications

Item	Specifications
Interface driving power supply	24 V DC±10%, 100 mA, supplied via terminal from outside
CPU driving power supply	5 V DC, 50mA, supplied via extension cable from PLC main unit

### Performance specifications

Item	Specifications
Conversion speed	When only voltage input and current input are used 500 μs x Number of used channels
Insulation method	Photocoupler insulates analog input area from PLC. DC/DC converter insulates power supply from analog I/O.
Number of occupied I/O points	Don't occupy any I/O points
Applicable PLC	Ex1n, Ex2n Series PLC, V1.40 or more

## Buffer Memories (BFM) lists

BFM No.	Description	Initial value
#0	Input mode selection of CH1 to CH4.	H000
#1	Input mode selection of CH5 to CH8.	H000
#2	Number of times of averaging of CH1 Setting range :1 to 8 times	8
#3	Number of times of averaging of CH2 Setting range :1 to 8 times	8
#4	Number of times of averaging of CH3 Setting range :1 to 8 times	8
#5	Number of times of averaging of CH4 Setting range :1 to 8 times	8
#6	Number of times of averaging of CH5 Setting range :1 to 8 times	8
#7	Number of times of averaging of CH6 Setting range :1 to 8 times	8
#8	Number of times of averaging of CH7 Setting range :1 to 8 times	8
#9	Number of times of averaging of CH8 Setting range :1 to 8 times	8
#10	CH1 data (immediate data or average data)	0
#11	CH2 data (immediate data or average data)	0
#12	CH3 data (immediate data or average data)	0
#13	CH4 data (immediate data or average data)	0
#14	CH5 data (immediate data or average data)	0
#15	CH6 data (immediate data or average data)	0
#16	CH7 data (immediate data or average data)	0
#17	CH8 data (immediate data or average data)	0
#18	CH1 to CH8 start conversion enable bit selection	H0000
...	Reserved	–
#22	Sets convenient functions (data addition, upper/lower limit value detection, sudden change detection and peak value hold.)	K1
#23	iat reference value	250
...	Reserved	–
#29	Error status	K0
#30	Model code & Serial No. of Version	K2050
#31	Reserved	–
#32	Operating time 0 to 64,800 (s). After that, 64,800 is kept. Measurement starts when power is turned on, and measured value is reset when power is turned off.	K0
#33	Reserved	
...	Reserved	–
#37	Temperature module environment temperature (Centigrade)	
#38	Temperature module environment temperature (Fahrenheit)	
...	Reserved	–
#41-48	Reserved	
#51-58	Reserved	

...	Reserved	
#60	When value = 2561, force module to restart (V1.28 or more is effective)	–
#61	CH1 addition data Setting range: -2,000 to +2,000 (valid while BFM #22 b0 is ON)	K0
#62	CH2 addition data Setting range: -2,000 to +2,000 (valid while BFM #22 b0 is ON)	K0
#63	CH3 addition data Setting range: -2,000 to +2,000 (valid while BFM #22 b0 is ON)	K0
#64	CH4 addition data Setting range: -2,000 to +2,000 (valid while BFM #22 b0 is ON)	K0
#65	CH5 addition data Setting range: -2,000 to +2,000 (valid while BFM #22 b0 is ON)	K0
#66	CH6 addition data Setting range: -2,000 to +2,000 (valid while BFM #22 b0 is ON)	K0
#67	CH7 addition data Setting range: -2,000 to +2,000 (valid while BFM #22 b0 is ON)	K0
#68	CH8 addition data Setting range: -2,000 to +2,000 (valid while BFM #22 b0 is ON)	K0
...	Reserved	–
#71	CH1 lower limit value error set value (valid while BFM #22 b1 is ON)	Minimum digital value inside input range
#72	CH2 lower limit value error set value (valid while BFM #22 b1 is ON)	Minimum digital value inside input range
#73	CH3 lower limit value error set value (valid while BFM #22 b1 is ON)	Minimum digital value inside input range
#74	CH4 lower limit value error set value (valid while BFM #22 b1 is ON)	Minimum digital value inside input range
#75	CH5 lower limit value error set value (valid while BFM #22 b1 is ON)	Minimum digital value inside input range
#76	CH6 lower limit value error set value (valid while BFM #22 b1 is ON)	Minimum digital value inside input range
#77	CH7 lower limit value error set value (valid while BFM #22 b1 is ON)	Minimum digital value inside input range
#78	CH8 lower limit value error set value (valid while BFM #22 b1 is ON)	Minimum digital value inside input range
...	Reserved	–
#81	CH1 upper limit value error set value (valid while BFM #22 b1 is ON)	Maximum digital value inside input range
#82	CH2 upper limit value error set value (valid while BFM #22 b1 is ON)	Maximum digital value inside input range
#83	CH3 upper limit value error set value (valid while BFM #22 b1 is ON)	Maximum digital value inside input range
#84	CH4 upper limit value error set value (valid while BFM #22 b1 is ON)	Maximum digital value inside input range
#85	CH5 upper limit value error set value (valid while BFM #22 b1 is ON)	Maximum digital value inside input range
#86	CH6 upper limit value error set value (valid while BFM #22 b1 is ON)	Maximum digital value inside input range
#87	CH7 upper limit value error set value (valid while BFM #22 b1 is ON)	Maximum digital value inside input range
#88	CH8 upper limit value error set value (valid while BFM #22 b1 is ON)	Maximum digital value inside input range
...	Reserved	–

#101	CH1 peak value (minimum value) (valid while BFM #22 b3 is ON)	
#102	CH2 peak value (minimum value) (valid while BFM #22 b3 is ON)	
#103	CH3 peak value (minimum value) (valid while BFM #22 b3 is ON)	
#104	CH4 peak value (minimum value) (valid while BFM #22 b3 is ON)	
#105	CH5 peak value (minimum value) (valid while BFM #22 b3 is ON)	
#106	CH6 peak value (minimum value) (valid while BFM #22 b3 is ON)	
#107	CH7 peak value (minimum value) (valid while BFM #22 b3 is ON)	
#108	CH8 peak value (minimum value) (valid while BFM #22 b3 is ON)	
#109	Peak value (minimum value) reset flag	K0
#110	Unusable	
#111	CH1 peak value (maximum value) (valid while BFM #22 b3 is ON)	
#112	CH2 peak value (maximum value) (valid while BFM #22 b3 is ON)	
#113	CH3 peak value (maximum value) (valid while BFM #22 b3 is ON)	
#114	CH4 peak value (maximum value) (valid while BFM #22 b3 is ON)	
#115	CH5 peak value (maximum value) (valid while BFM #22 b3 is ON)	
#116	CH6 peak value (maximum value) (valid while BFM #22 b3 is ON)	
#117	CH7 peak value (maximum value) (valid while BFM #22 b3 is ON)	
#118	CH8 peak value (maximum value) (valid while BFM #22 b3 is ON)	
#119	Peak value (maximum value) reset flag	K0
...	Reserved	-
#148	Count scan times(Circular counter 0-65536)	
...	Reserved	-
#180	K Type Thermocouple, temperature coefficient $\alpha$	
#181	J Type Thermocouple, temperature coefficient $\alpha$	
#182	T Type Thermocouple, temperature coefficient $\alpha$	
...	Reserved	
#192-199	CH1 data history	
#200-207	CH2 data history	
#208-215	CH3 data history	
#216-223	CH4 data history	
#224-231	CH5 data history	
#232-239	CH6 data history	
#240-247	CH7 data history	
#248-255	CH8 data history	

## Details of buffer memories

### 1 BFM #0, #1: Input mode selection

The input mode by writing a numeric value to BFM #0 and BFM#1 to assign CH1 to CH8 operation mode to BFM#0. In the input mode specification, each BFM is expressed in a 4-digit hexadecimal code, and each channel No. is assigned to each digit.

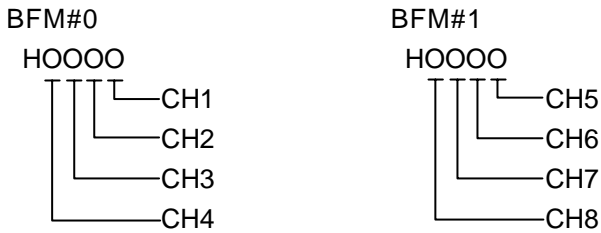

- O=0: Voltage input mode (-10 to +10V), resolution (20V x 1/32,000)
- O=1: Voltage input mode (-10 to +10V), resolution (20V x 1/8,000)
- O=2: Voltage input mode, analog value direct display (-10,000 to +10,000), resolution (20V x 1/20,000)
- O=3: Current input mode (4 to 20mA), resolution (16mA x 1/8,000)
- O=4: Current input mode (4 to 20mA), resolution (16mA x 1/4,000)
- O=5: Current input mode, analog value direct display (4,000 to 20,000), resolution 2.00 $\mu$ A
- O=6: Current input mode (-20 to 20mA), resolution (40mA x 1/16,000)
- O=7: Current input mode (-20 to 20mA), resolution (40mA x 1/8,000)
- O=8: Current input mode, analog value direct display (-20,000 to +20,000), resolution (40mA x 1/40,000)
- O=9: Thermocouple input mode, K type, Celsius display (-100 to +1,200°C), resolution 0.1°C
- O=A: Thermocouple input mode, J type, Celsius display (-100 to +600°C), resolution 0.1°C
- O=B: Thermocouple input mode, T type, Celsius display (-100 to +350°C), resolution 0.1°C
- O=C: Thermocouple input mode, K type, Fahrenheit display (-148 to +1,832°F), resolution 0.1°F
- O=D: Thermocouple input mode, J type, Fahrenheit display (-148 to +1,112°F), resolution 0.1°F
- O=E: Thermocouple input mode, T type, Fahrenheit display (-148 to +662°F), resolution 0.1°F
- O=F: Reserved

### 2 BFM #2 TO BFM #9: Number of times of averaging

When using BFM #10 to #17 as the average data, write the number of times of averaging to BFM #2 to BFM #9. The setting range of the number of times of averaging is 1 to 8. If select the immediate data, value of BFM#2 to BFM#9 is 1.

### 3 BFM #10 to BFM #17: Analog data

The A/D conversion data of each channel is written to BFM #10 to BFM #17.

You can select the immediate (current value) data or the average data by setting the number of times of averaging (BFM #2 to BFM # 9).

### 4 BFM #18: Bxxxxxxxxnnnnnnnn

Bit No.	b15 to b18	b7	b6	b5	b4	b3	b2	b1	b0
n=0	Reserved	CH8 disable	CH7 disable	CH6 disable	CH5 disable	CH4 disable	CH3 disable	CH2 disable	CH1 disable
n=1	Reserved	CH8 enable	CH7 enable	CH6 enable	CH5 enable	CH4 enable	CH3 enable	CH2 enable	CH1 enable

### 5 BFM #22: Sets convenient functions

The functions described below are assigned to b0 to b3 of BFM #22. When a bit is set to ON, the assigned function becomes valid.



b0 : Data addition function

When this bit set to ON, the measured value will add addition value and stored into BFM#10~BFM#17.

b1 : Upper / lower limit value detection function

Reserved

b2 : Reserved

b3 : When this bit set to ON, peak value will be stored into BFM#101~BFM#108, BFM#111~BFM#118.

## **6 BFM#30: Model code**

Fixed value : "K2xxx". xxx is version code

# Standard I/O Characteristics

0. Voltage input, -10 to +10V, 20V x 1/32,000

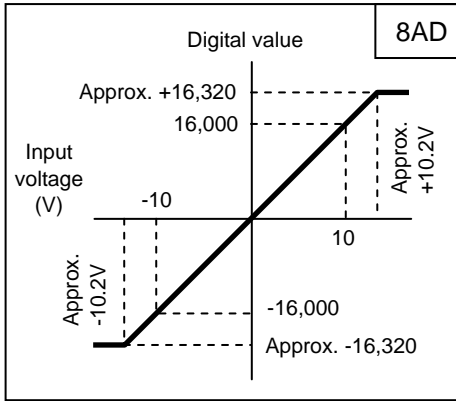

1. Voltage input, -10 to +10V, 20V x 1/8,000

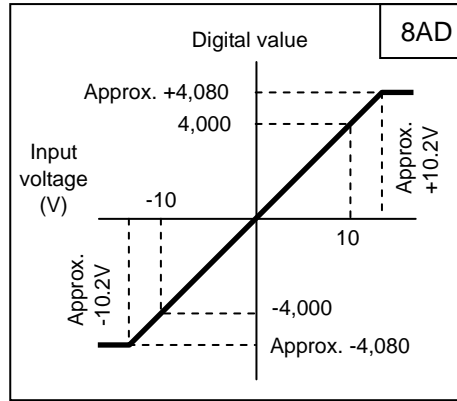

2. Voltage input, direct display (-10,000 to +10,000)

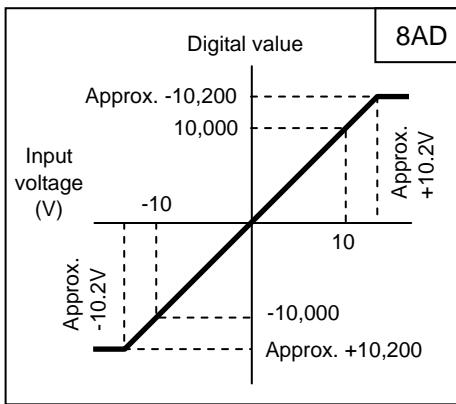

3. Current input, 4 to 20mA, 16mA x 1/8,000

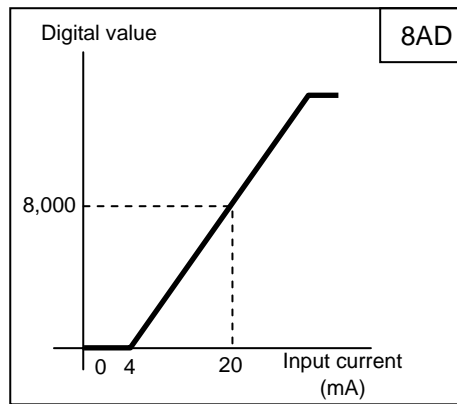

4. Current input, 4 to 20mA, 16mA x 1/4,000

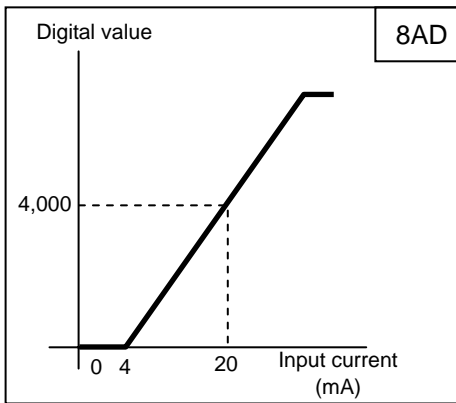

5. Current input, direct display (4,000 to 20,000)

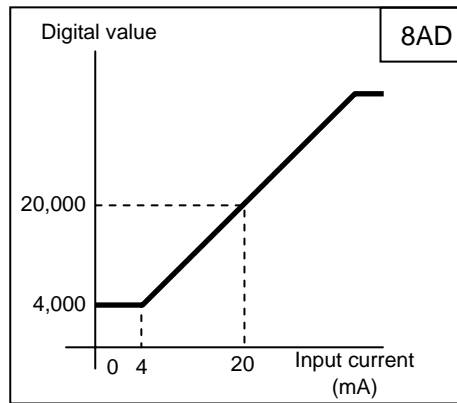

6. Current input, -20 to +20mA, 40mA x 1/16,000

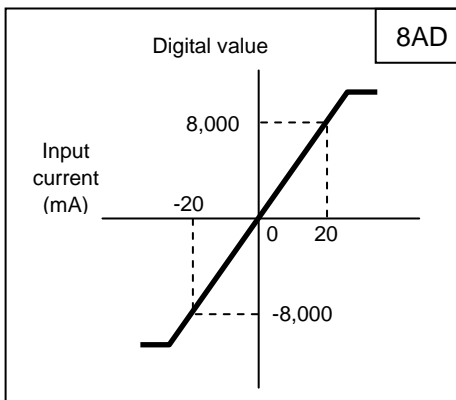

7. Current input, -20 to +20mA, 40mA x 1/8,000

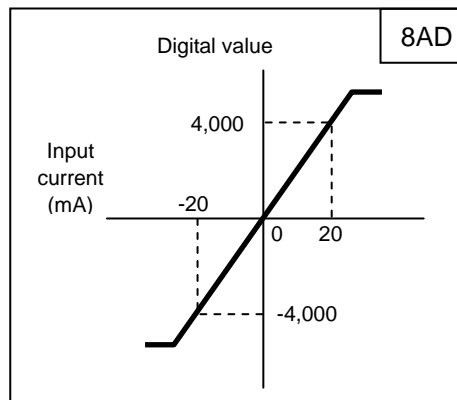

8. Current input, direct display (-20,000 to +20,000)

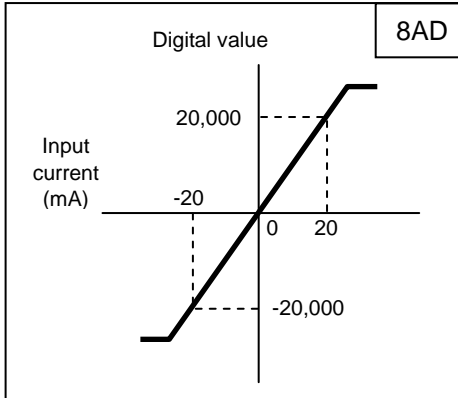

9. Thermocouple input, K type, Celsius

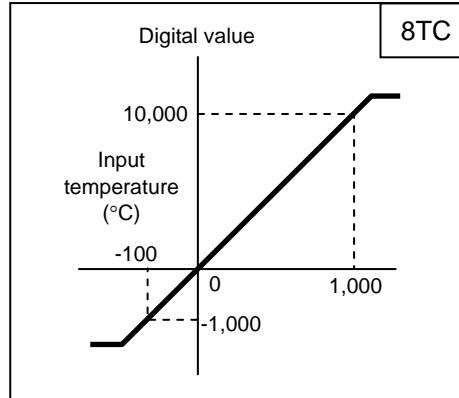

A. Thermocouple input, J type, Celsius

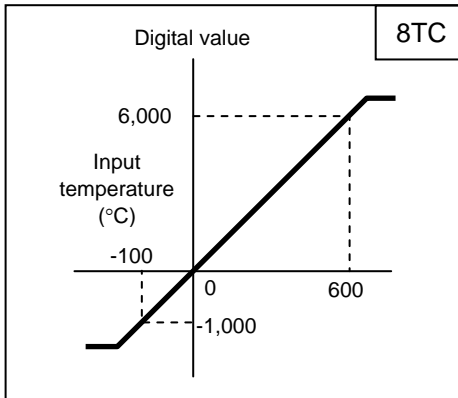

B. Thermocouple input, T type, Celsius

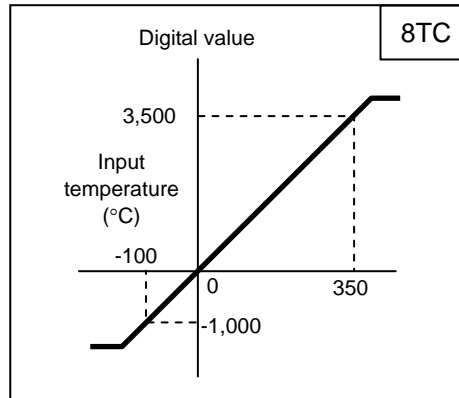

C. Thermocouple input, K type, Fahrenheit

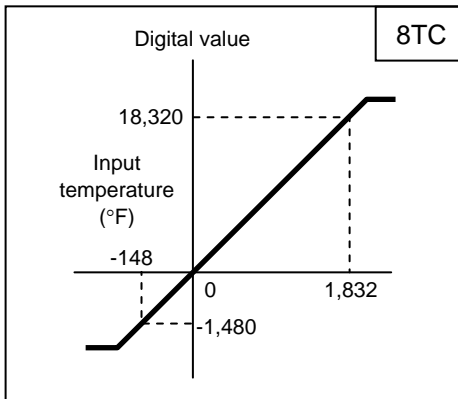

D. Thermocouple input, J type, Fahrenheit

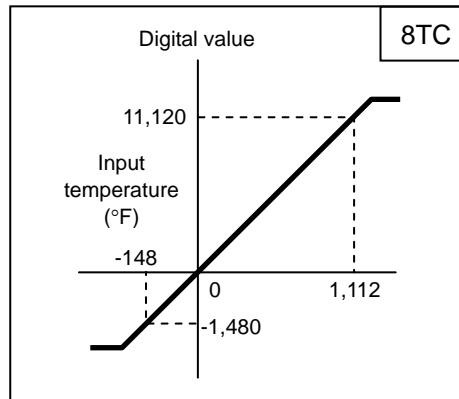

E. Thermocouple input, T type, Fahrenheit

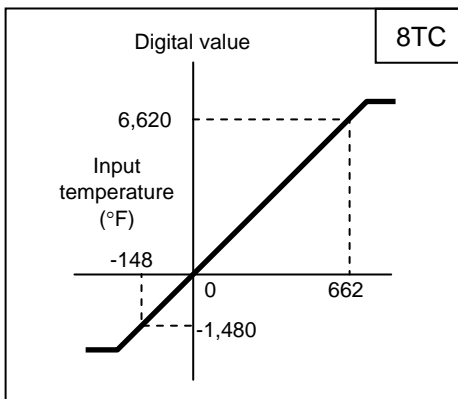

# FROM/TO Instruction

## FROM Instruction

FNC(78)			16 bits: FROM(P) ----- 9 steps	EX	EX <sub>1S</sub>	EX <sub>1N</sub>	EX <sub>2N</sub>
D	FROM	P	32 bits: (D)FROM(P) -----17 steps				

Operands: |← [D.] →|

K.H.	KnX	KnY	KnM	KnS	T	C	D	V,Z
------	-----	-----	-----	-----	---	---	---	-----

Operands: |← →| m1 = 0 ~ 7 no. of special module  
 m2.= 0 ~ 32767 no. of buffer memory (BFM)  
 n.= 1 ~ 31 no. of read (when D, n=1~15)

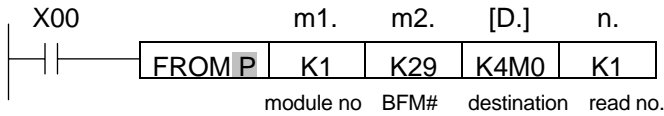

◆ When X00 ON, the buffer memory of special module BFM#29 to be read out and stored into M00~M15.

<< Special Device Module Number m1 >>

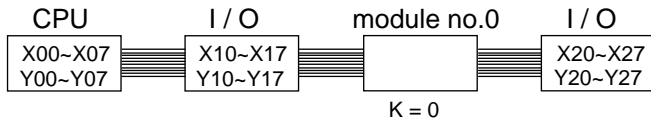

- ◆ The BFM is the memory address of special module.
- ◆ The number of special module is address to NO.0~NO.7 and beginning with the one closest to the CPU unit.
- ◆ The special module can up to 8 maximum, and no occupy i/o points.

## TO instruction

FNC(79)			16 bits: TO(P) ----- 9 steps	EX	EX <sub>1S</sub>	EX <sub>1N</sub>	EX <sub>2N</sub>
D	TO	P	32 bits: (D)TO(P) ----- 17 steps				

Operands: |← [S.] →|

K.H.	KnX	KnY	KnM	KnS	T	C	D	V,Z
------	-----	-----	-----	-----	---	---	---	-----

Operands: |← →| m1 = 0 ~ 7 no. of special module  
 m2.= 0 ~ 32767 no. of buffer memory (BFM)  
 n.= 1 ~ 31 no. of write (when D, n=1~15)

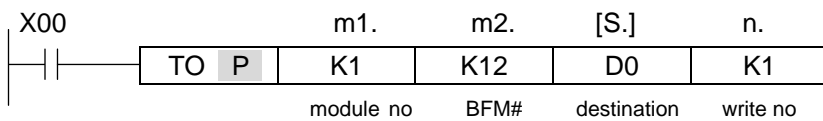

- ◆ When X00 ON, the content of D0 to be write into the buffer memory BFM#12 of the special module NO.1
- ◆ If used pulse command can decrement cycle time.

<< Number of Read n >>

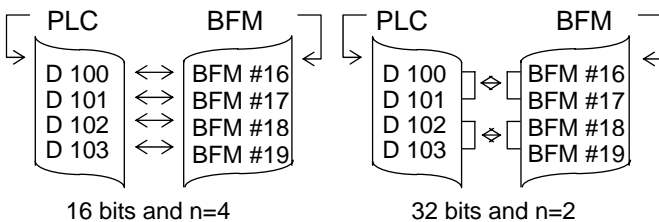



# LIYAN PROGRAMMABLE LOGIC CONTROLLER

Ex1n8AD-edoc0303v128b

LIYAN ELECTRIC INDUSTRIAL LTD.

TEL : 886 - 4 - 25613700

FAX : 886 - 4 - 25613408

Website : <http://www.liyanplc.com>

E - mail : [twliyan@ms16.hinet.net](mailto:twliyan@ms16.hinet.net)